

Pump Model CPS 125-80-270

Speed 2900rpm

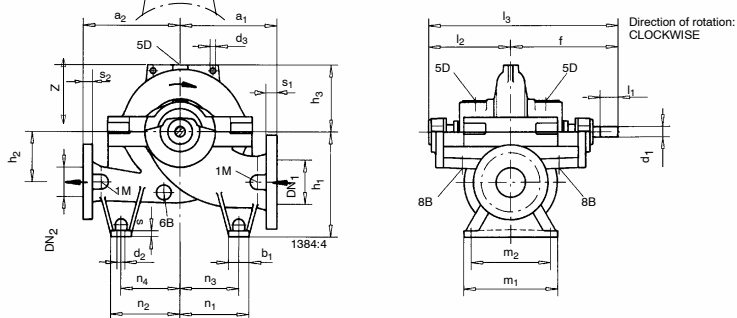
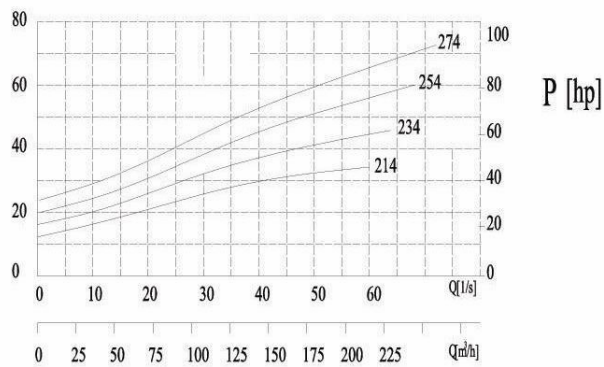
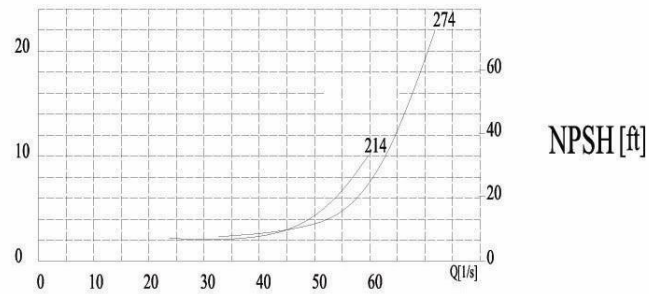
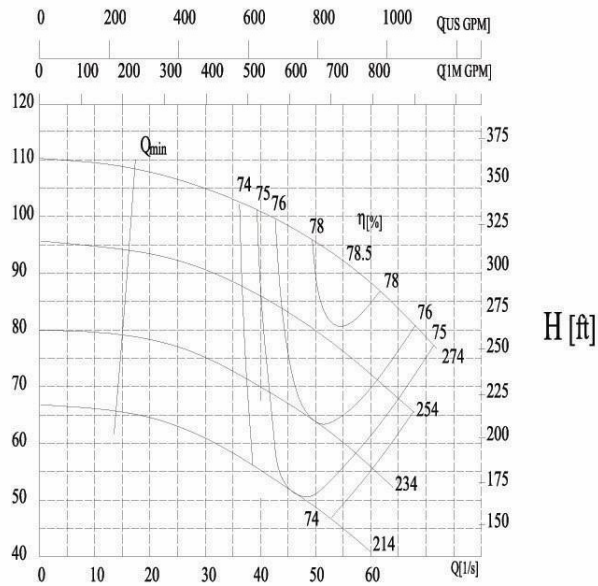

Pump Size	FLANGE DIMENSIONS						PUMP DIMENSIONS							
	DN1	DN2	s1	s2	a1	a2	d3	f	h1	h2	h3	l2	l3	z
CPS 125-80-270	125	80	34	29	300	300	19	415	315	140	190	300	715	380
	FOOT DIMENSIONS						SHAFT			PUMP WEIGHT				
	b1	d2	m1	m2	n1	n2	n3	n4	s	d1	L1	(kg)		
70	18	320	270	205	205	170	170	20	35	80	195			